

U18 F44KG

Compétiteurs A

| # | Nom | Club | 1 | 2 | 3 | Vic. | Pts | Pos |
|---|---------------------|------------------------|----|----|----|------|-----|-----|
| 1 | ESPARBES Kylee | BC/Steveston Judo Club | XX | | | 0 | 0 | 3 |
| 2 | MCCRISTALL Angelina | ON/Upper Canada | 5 | XX | | 1 | 5 | 2 |
| 3 | DUSSAULT Leanne | QC/Asbestos-Danville | 10 | 10 | XX | 2 | 20 | 1 |

Pool A

| Match | Blanc | | | Bleu | Résultat | Temps | Code |
|-------|---------------------|---|---|---------------------|----------|-------|------|
| A-10 | ESPARBES Kylee | 1 | 2 | MCCRISTALL Angelina | 0 - 5 | 12:31 | GSW |
| A-36 | ESPARBES Kylee | 1 | 3 | DUSSAULT Leanne | 0 - 10 | 0:40 | IPO |
| A-51 | MCCRISTALL Angelina | 2 | 3 | DUSSAULT Leanne | 0 - 10 | 4:00 | WIP |

Compétiteurs B

| # | Nom | Club | 4 | 5 | 6 | Vic. | Pts | Pos |
|---|--------------------|------------------------|----|----|----|------|-----|-----|
| 4 | TURMEL Marie-Lune | QC/Judo Blainville | XX | | | 0 | 0 | 3 |
| 5 | IWAASA Brynn | AB/Lethbridge Kyodokan | 10 | XX | 5 | 2 | 15 | 1 |
| 6 | DANILKOV Ekaterina | BC/Steveston Judo Club | 10 | | XX | 1 | 10 | 2 |

Pool B

| Match | Blanc | | | Bleu | Résultat | Temps | Code |
|-------|-------------------|---|---|--------------------|----------|-------|------|
| A-11 | TURMEL Marie-Lune | 4 | 5 | IWAASA Brynn | 0 - 10 | 3:02 | IPO |
| A-37 | TURMEL Marie-Lune | 4 | 6 | DANILKOV Ekaterina | 0 - 10 | 1:09 | IPO |
| A-52 | IWAASA Brynn | 5 | 6 | DANILKOV Ekaterina | 5 - 0 | 4:00 | WAZ |

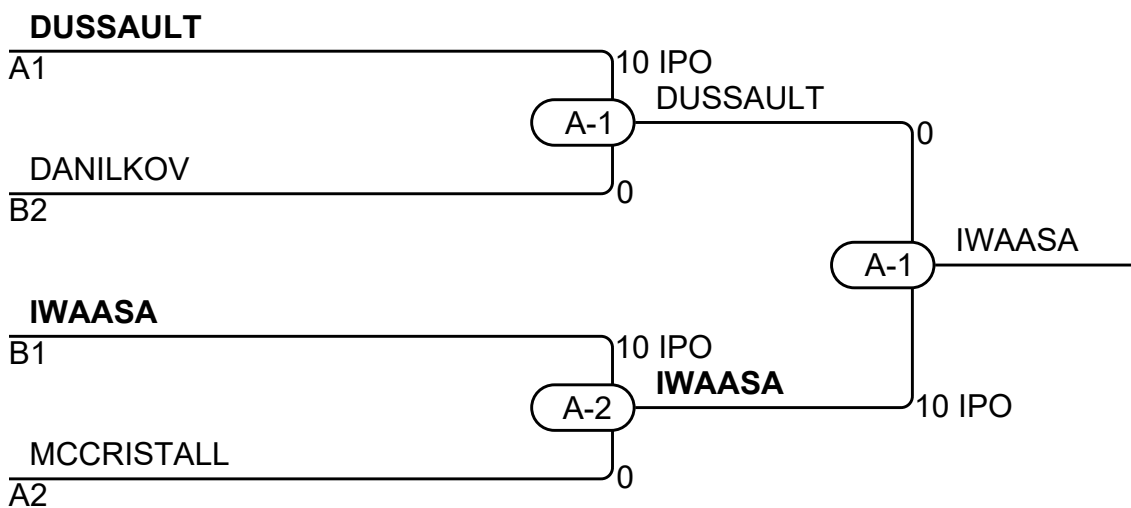

Résultats

| Pos | Nom |
|-----|--|
| 1 | IWAASA Brynn, AB/Lethbridge Kyodokan |
| 2 | DUSSAULT Leanne, QC/Asbestos-Danville |
| 3 | DANILKOV Ekaterina, BC/Steveston Judo Club |
| 3 | MCCRISTALL Angelina, ON/Upper Canada |

U18 F48KG

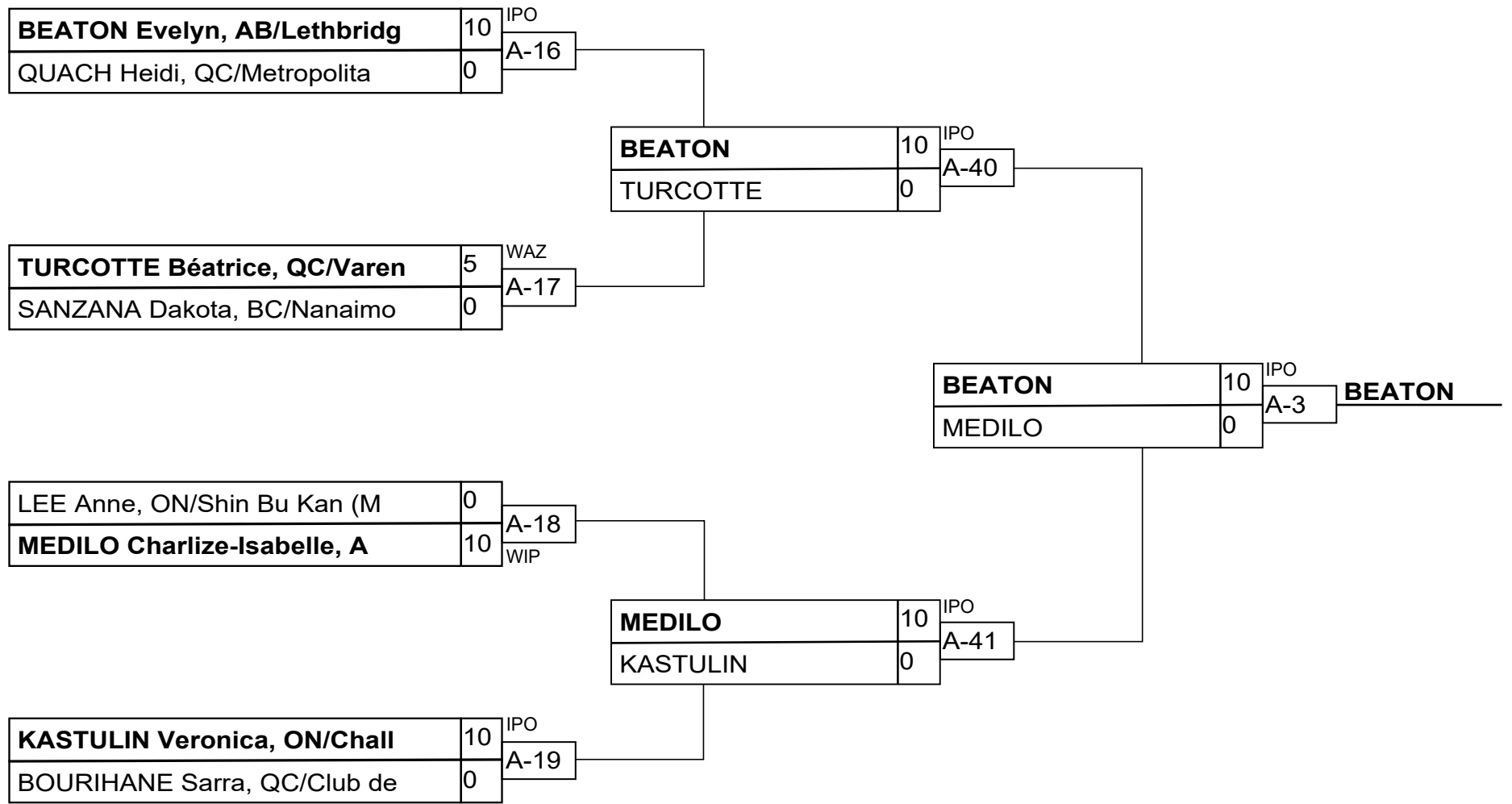

Résultats

| Pos | Nom |
|-----|--------------------------|
| 1 | BEATON Evelyn, AB/Lethbr |
| 2 | MEDILO Charlize-Isabelle |
| 3 | TURCOTTE Béatrice, QC/Va |
| 3 | SANZANA Dakota, BC/Nanai |

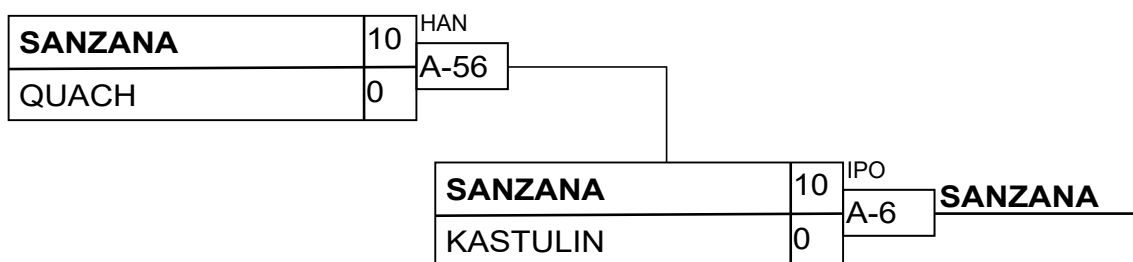
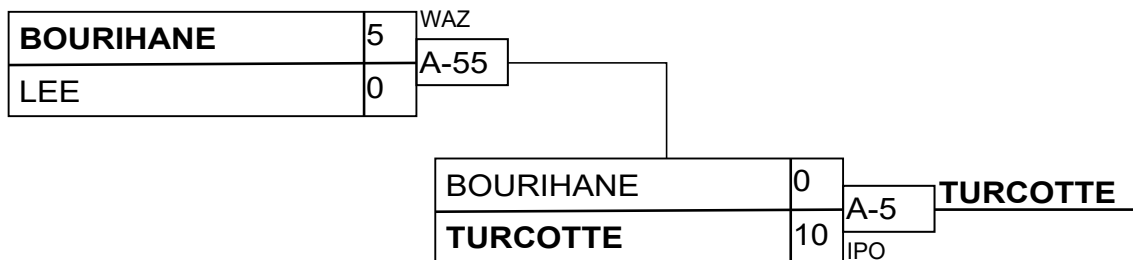

U18 F52KG

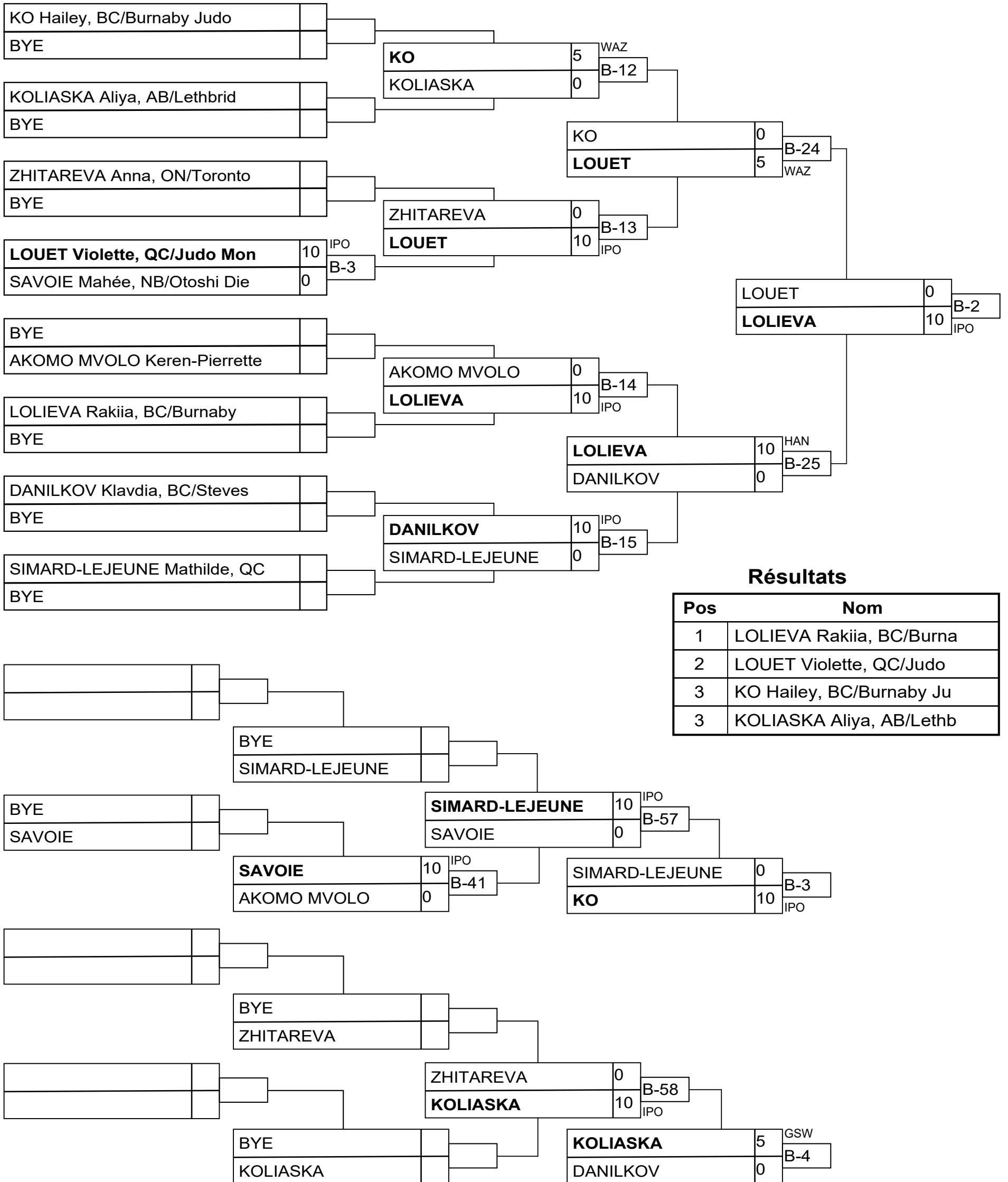

Résultats

| Pos | Nom |
|-----|--------------------------|
| 1 | LOLIEVA Rakiia, BC/Burna |
| 2 | LOUET Violette, QC/Judo |
| 3 | KO Hailey, BC/Burnaby Ju |
| 3 | KOLIASKA Aliya, AB/Lethb |

U18 F57KG

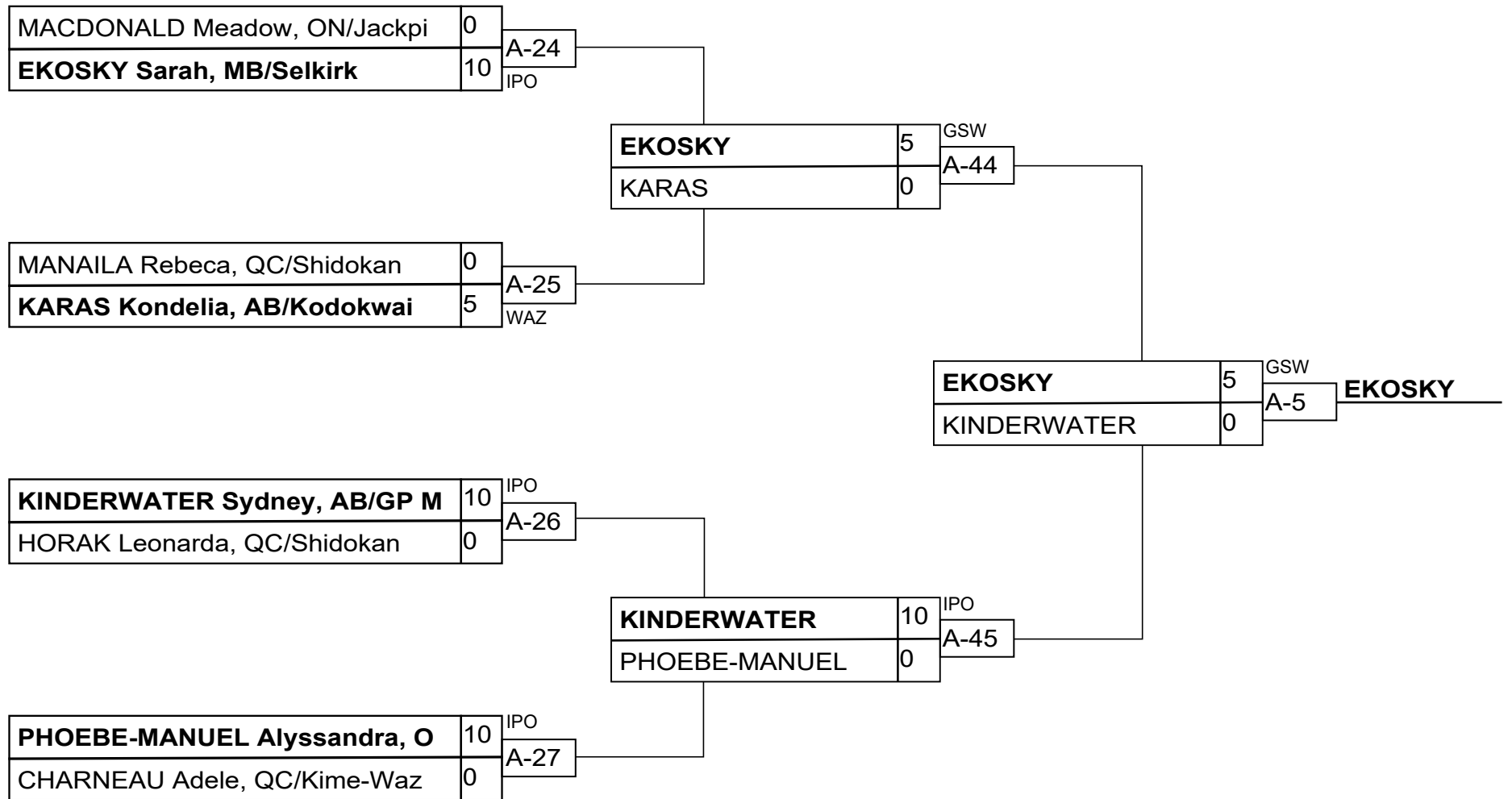

Résultats

| Pos | Nom |
|-----|--------------------------|
| 1 | EKOSKY Sarah, MB/Selkirk |
| 2 | KINDERWATER Sydney, AB/G |
| 3 | KARAS Kondelia, AB/Kodok |
| 3 | PHOEBE-MANUEL Alyssandra |

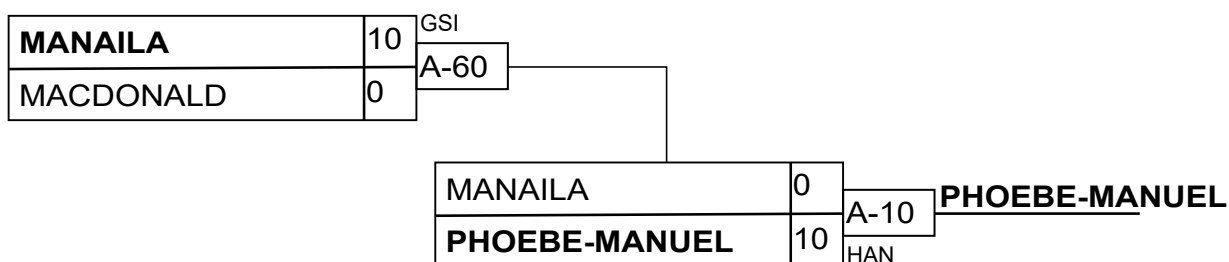
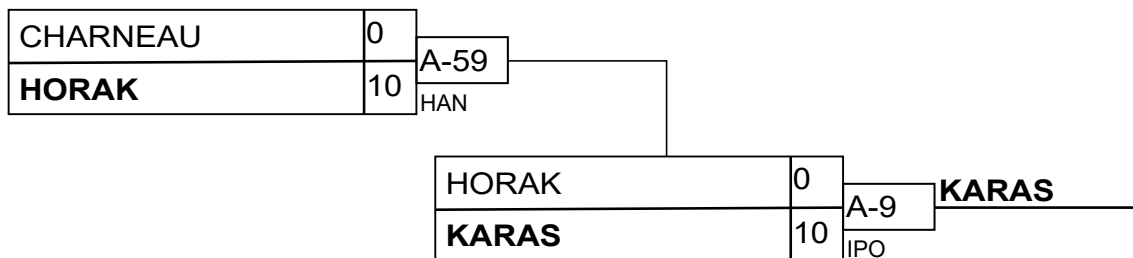

U18 F63KG

Compétiteurs A

| # | Nom | Club | 1 | 2 | 3 | Vic. | Pts | Pos |
|---|----------------|-----------------------|----|----|----|------|-----|-----|
| 1 | MORISHO Nyota | BC/Victoria Judo Club | XX | | 10 | 1 | 10 | 2 |
| 2 | SIMARD Justine | QC/Metropolitain | 10 | XX | 5 | 2 | 15 | 1 |
| 3 | BIRON Laurence | QC/Varenes | | | XX | 0 | 0 | 3 |

Pool A

| Match | Blanc | | | Bleu | Résultat | Temps | Code |
|-------|-----------------------|---|---|-----------------------|----------|-------|------|
| B-28 | MORISHO Nyota | 1 | 2 | SIMARD Justine | 0 - 10 | 2:25 | IPO |
| B-44 | MORISHO Nyota | 1 | 3 | BIRON Laurence | 10 - 0 | 1:53 | IPO |
| B-61 | SIMARD Justine | 2 | 3 | BIRON Laurence | 5 - 0 | 5:49 | GSW |

Compétiteurs B

| # | Nom | Club | 4 | 5 | 6 | Vic. | Pts | Pos |
|---|-----------------|------------------|----|----|----|------|-----|-----|
| 4 | ROBERTSON Loika | QC/St-Jean Bosco | XX | | | 0 | 0 | 3 |
| 5 | NORMIL Lara | QC/Metropolitain | 5 | XX | 5 | 2 | 10 | 1 |
| 6 | VILLA Rebecca | MB/Nakamura | 10 | | XX | 1 | 10 | 2 |

Pool B

| Match | Blanc | | | Bleu | Résultat | Temps | Code |
|-------|--------------------|---|---|----------------------|----------|-------|------|
| B-29 | ROBERTSON Loika | 4 | 5 | NORMIL Lara | 0 - 5 | 4:00 | WAZ |
| B-45 | ROBERTSON Loika | 4 | 6 | VILLA Rebecca | 0 - 10 | 4:10 | HAN |
| B-62 | NORMIL Lara | 5 | 6 | VILLA Rebecca | 5 - 0 | 4:00 | WAZ |

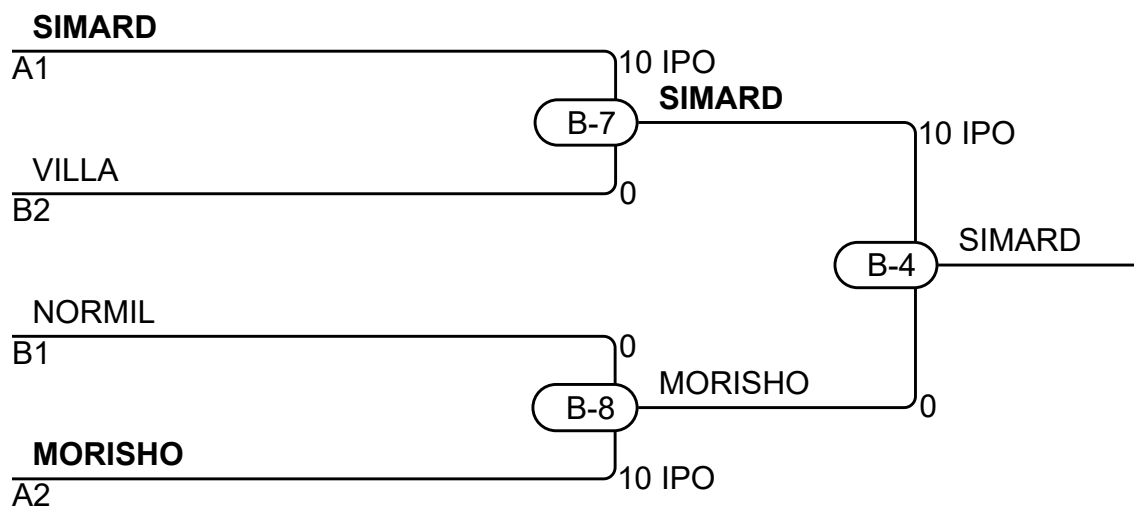

Résultats

| Pos | Nom |
|-----|--------------------------------------|
| 1 | SIMARD Justine, QC/Metropolitain |
| 2 | MORISHO Nyota, BC/Victoria Judo Club |
| 3 | VILLA Rebecca, MB/Nakamura |
| 3 | NORMIL Lara, QC/Metropolitain |

U18 F70KG

Compétiteurs

| # | Nom | Club | 1 | 2 | 3 | 4 | 5 | Vic. | Pts | Pos |
|---|--------------------|--------------------------|----|----|----|----|----|------|-----|-----|
| 1 | BRAZEAU Myriam | QC/Perrot Shima | XX | 5 | 10 | 10 | 10 | 4 | 35 | 1 |
| 2 | CALDER Mira | BC/Kokushikai | | XX | 10 | 10 | 5 | 3 | 25 | 2 |
| 3 | PIENKOWSKI Coralea | AB/Lethbridge Kyodokan | | | XX | | | 0 | 0 | 5 |
| 4 | LOWENSTEIN Jade | BC/Penticton Judo club | | | 10 | XX | | 1 | 10 | 4 |
| 5 | LUND Tianna | BC/Campbell River Judo C | | | 10 | 10 | XX | 2 | 20 | 3 |

Matches

| Match | Blanc | | | Bleu | Résultat | Temps | Code |
|-------|-----------------------|---|---|------------------------|----------|-------|------|
| A-2 | LOWENSTEIN Jade | 4 | 5 | LUND Tianna | 0 - 10 | 0:39 | IPO |
| A-3 | BRAZEAU Myriam | 1 | 2 | CALDER Mira | 5 - 0 | 0:40 | WAZ |
| A-8 | PIENKOWSKI Coralea | 3 | 4 | LOWENSTEIN Jade | 0 - 10 | 3:53 | WIP |
| A-9 | BRAZEAU Myriam | 1 | 5 | LUND Tianna | 10 - 0 | 0:07 | IPO |
| A-30 | CALDER Mira | 2 | 3 | PIENKOWSKI Coralea | 10 - 0 | 2:29 | IPO |
| A-31 | BRAZEAU Myriam | 1 | 4 | LOWENSTEIN Jade | 10 - 0 | 0:54 | IPO |
| A-47 | PIENKOWSKI Coralea | 3 | 5 | LUND Tianna | 0 - 10 | 0:34 | IPO |
| A-48 | CALDER Mira | 2 | 4 | LOWENSTEIN Jade | 10 - 0 | 0:30 | IPO |
| A-63 | BRAZEAU Myriam | 1 | 3 | PIENKOWSKI Coralea | 10 - 0 | 1:49 | WIP |
| A-64 | CALDER Mira | 2 | 5 | LUND Tianna | 5 - 0 | 4:57 | WAZ |

Résultats

| Pos | Nom |
|-----|--|
| 1 | BRAZEAU Myriam, QC/Perrot Shima |
| 2 | CALDER Mira, BC/Kokushikai |
| 3 | LUND Tianna, BC/Campbell River Judo Club |
| 4 | LOWENSTEIN Jade, BC/Penticton Judo club |
| | |

U18 F70KG (TB)

Compétiteurs

| # | Nom | Club | 1 | 2 | 3 | Vic. | Pts | Pos |
|---|----------------|--------------------------|----|----|----|------|-----|-----|
| 1 | LUND Tianna | BC/Campbell River Judo C | XX | | | 0 | 0 | 3 |
| 2 | CALDER Mira | BC/Kokushikai | 5 | XX | | 1 | 5 | 2 |
| 3 | BRAZEAU Myriam | QC/Perrot Shima | 10 | 5 | XX | 2 | 15 | 1 |

Matches

| Match | Blanc | | | Bleu | Résultat | Temps | Code |
|-------|-------------|---|---|----------------|----------|-------|------|
| C-1 | LUND Tianna | 1 | 2 | CALDER Mira | 0 - 5 | 0:12 | WAZ |
| C-2 | LUND Tianna | 1 | 3 | BRAZEAU Myriam | 0 - 10 | 0:14 | GSI |
| C-3 | CALDER Mira | 2 | 3 | BRAZEAU Myriam | 0 - 5 | 0:09 | GSW |

Résultats

| Pos | Nom |
|-----|---------------------------------|
| 1 | BRAZEAU Myriam, QC/Perrot Shima |
| 2 | CALDER Mira, BC/Kokushikai |
| | |

U18 Fo70kg

Compétiteurs

| # | Nom | Club | 1 | 2 | 3 | 4 | 5 | Vic. | Pts | Pos |
|---|-------------------|---------------------|----|----|----|----|----|------|-----|-----|
| 1 | LINGLEY Brandi | NB/Tani Koi | XX | | | 10 | | 1 | 10 | 4 |
| 2 | DOUGLAS Asia | ON/Toronto Judo Kai | 10 | XX | 10 | 10 | 10 | 4 | 40 | 1 |
| 3 | SAHRAOUI Maya | QC/Judo Blainville | 10 | | XX | 10 | | 2 | 20 | 3 |
| 4 | FOREST Frédérique | QC/Kiseki | | | | XX | | 0 | 0 | 5 |
| 5 | KEYS Jannessa | SK/Saskatoon YMCA | 10 | | 10 | 10 | XX | 3 | 30 | 2 |

Matches

| Match | Blanc | | | Bleu | Résultat | Temps | Code |
|-------|-----------------------|---|---|----------------------|----------|-------|------|
| B-6 | FOREST Frédérique | 4 | 5 | KEYS Jannessa | 0 - 10 | 1:00 | WIP |
| B-7 | LINGLEY Brandi | 1 | 2 | DOUGLAS Asia | 0 - 10 | 1:59 | IPO |
| B-20 | SAHRAOUI Maya | 3 | 4 | FOREST Frédérique | 10 - 0 | 0:50 | IPO |
| B-21 | LINGLEY Brandi | 1 | 5 | KEYS Jannessa | 0 - 10 | 1:00 | IPO |
| B-33 | DOUGLAS Asia | 2 | 3 | SAHRAOUI Maya | 10 - 0 | 0:53 | WIP |
| B-34 | LINGLEY Brandi | 1 | 4 | FOREST Frédérique | 10 - 0 | 0:42 | WIP |
| B-49 | SAHRAOUI Maya | 3 | 5 | KEYS Jannessa | 0 - 10 | 2:29 | WIP |
| B-50 | DOUGLAS Asia | 2 | 4 | FOREST Frédérique | 10 - 0 | 0:57 | IPO |
| B-66 | LINGLEY Brandi | 1 | 3 | SAHRAOUI Maya | 0 - 10 | 1:02 | WIP |
| B-67 | DOUGLAS Asia | 2 | 5 | KEYS Jannessa | 10 - 0 | 0:24 | IPO |

Résultats

| Pos | Nom |
|-----|-----------------------------------|
| 1 | DOUGLAS Asia, ON/Toronto Judo Kai |
| 2 | KEYS Jannessa, SK/Saskatoon YMCA |
| 3 | SAHRAOUI Maya, QC/Judo Blainville |
| 4 | LINGLEY Brandi, NB/Tani Koi |
| | |

U18 M46KG

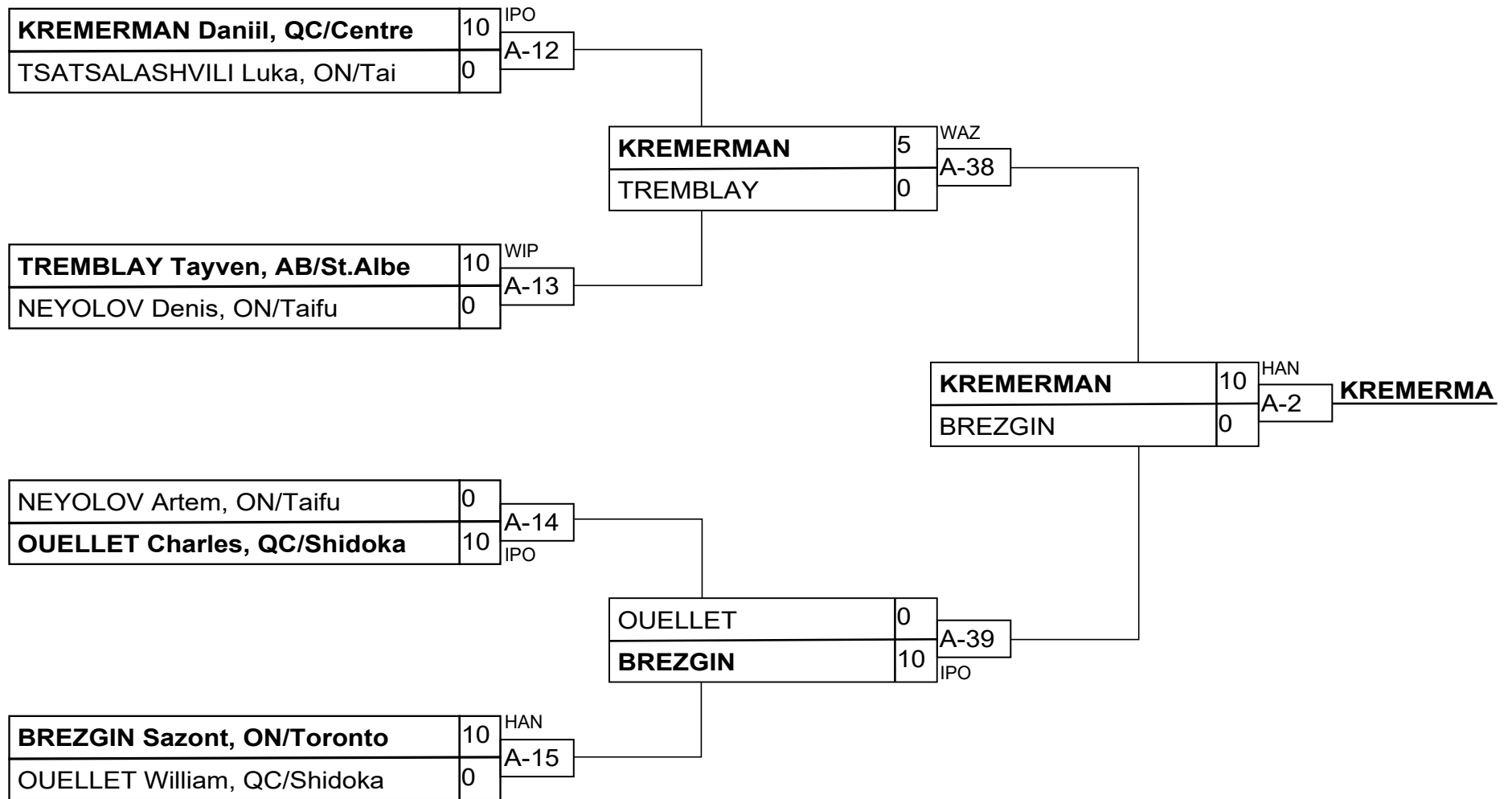

Résultats

| Pos | Nom |
|-----|--------------------------|
| 1 | KREMERMAN Daniil, QC/Cen |
| 2 | BREZGIN Sazont, ON/Toron |
| 3 | TREMBLAY Tayven, AB/St.A |
| 3 | OUELLET Charles, QC/Shid |

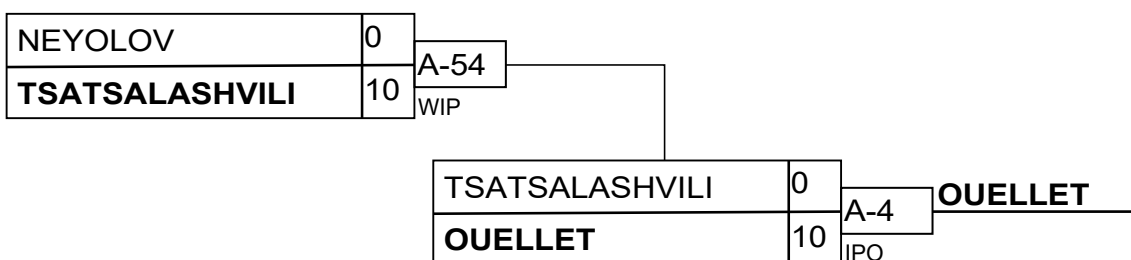
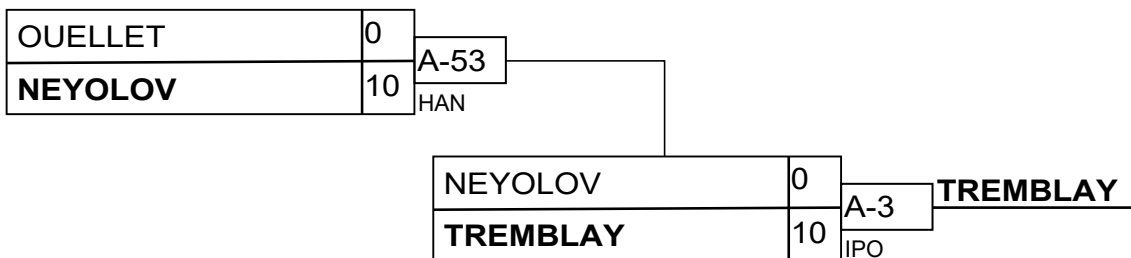

U18 M50KG

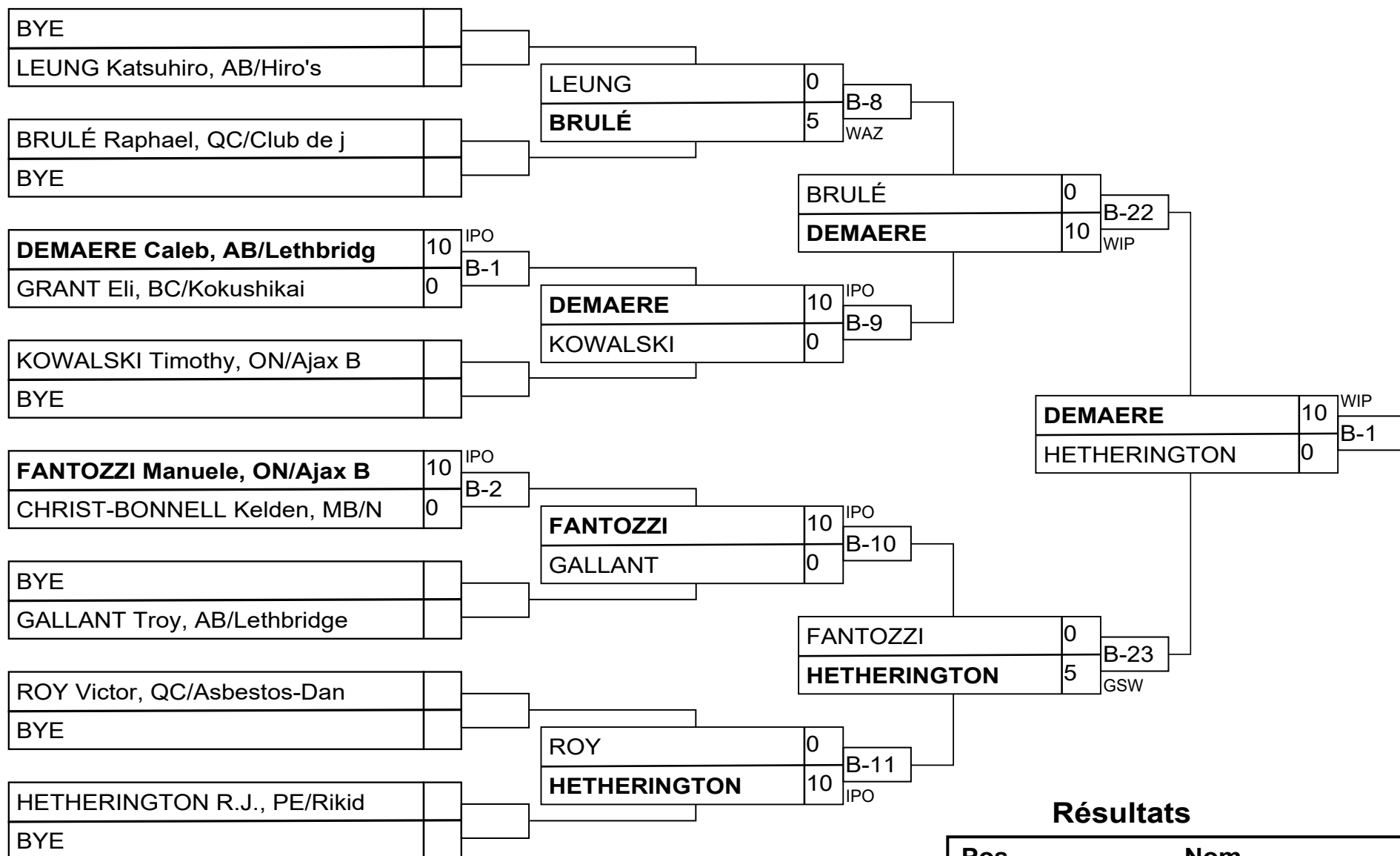

Résultats

| Pos | Nom |
|-----|--------------------------|
| 1 | DEMAERE Caleb, AB/Lethbr |
| 2 | HETHERINGTON R.J., PE/Ri |
| 3 | BRULÉ Raphael, QC/Club d |
| 3 | FANTOZZI Manuele, ON/Aja |

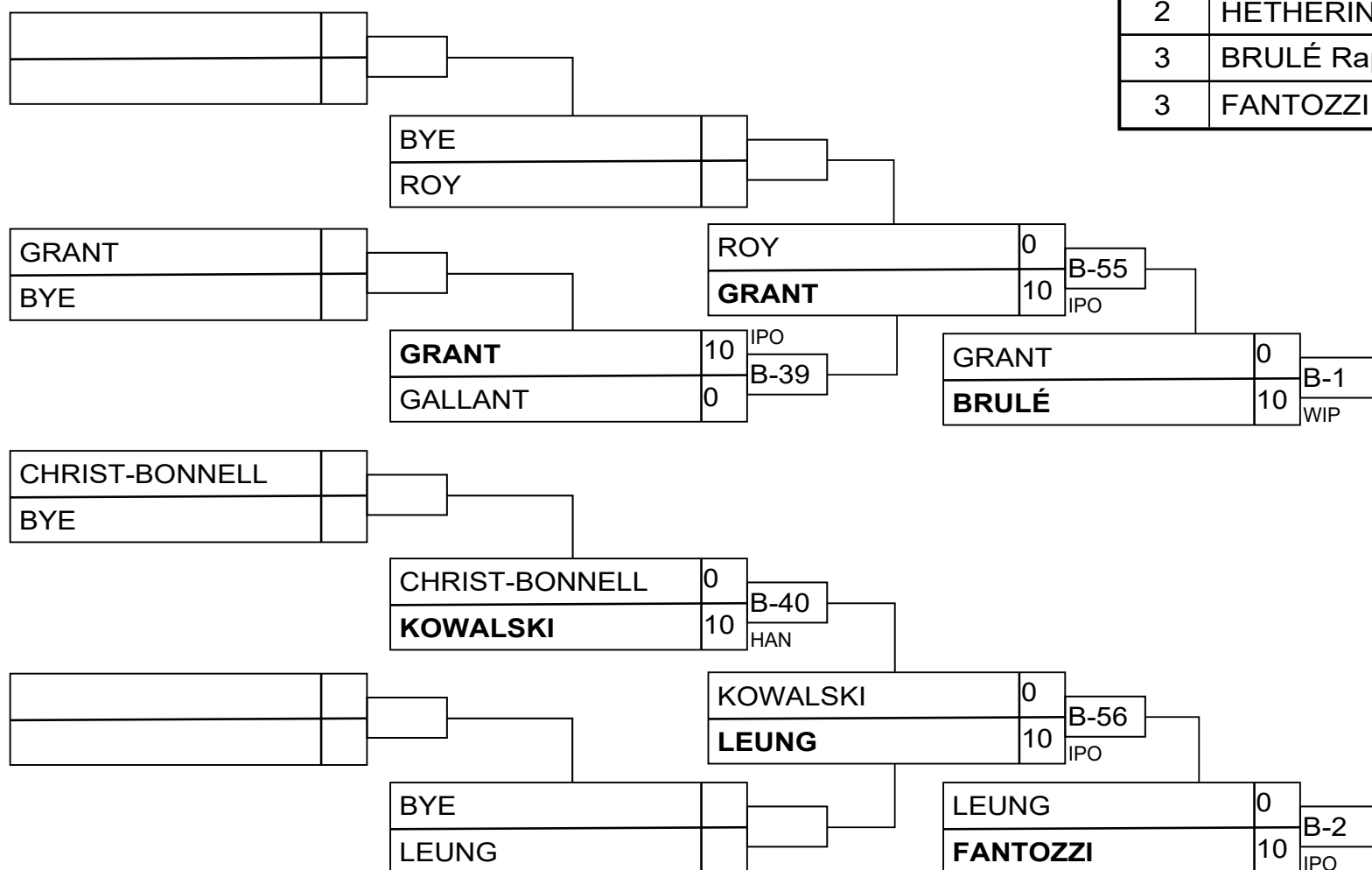

U18 M55KG

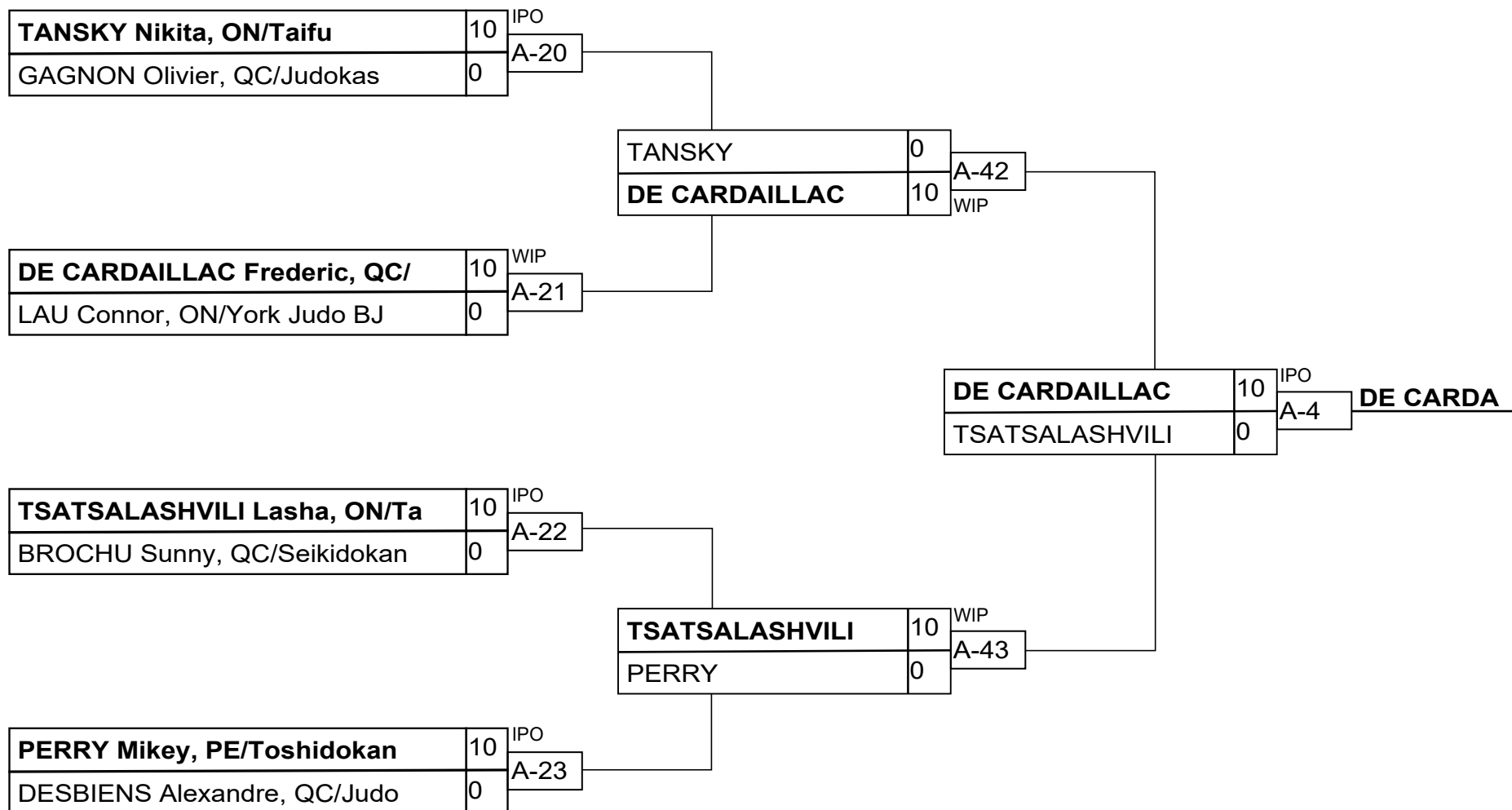

Résultats

| Pos | Nom |
|-----|--------------------------|
| 1 | DE CARDAILLAC Frederic, |
| 2 | TSATSALASHVILI Lasha, ON |
| 3 | TANSKY Nikita, ON/Taifu |
| 3 | PERRY Mikey, PE/Toshidok |

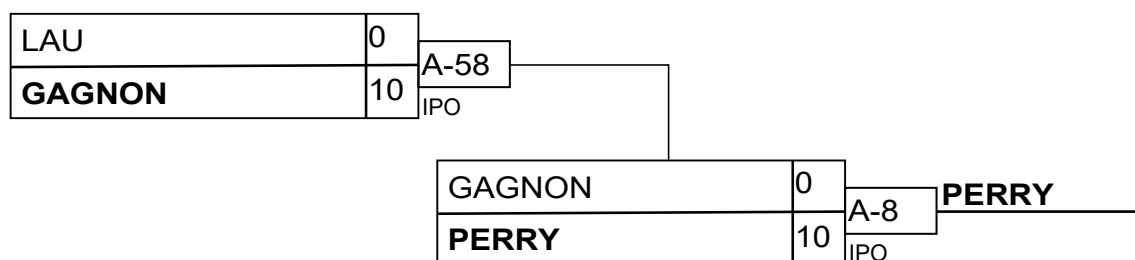
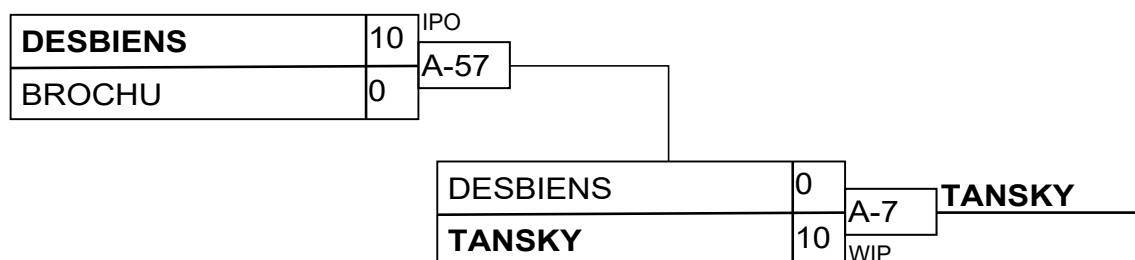

U18 M60KG

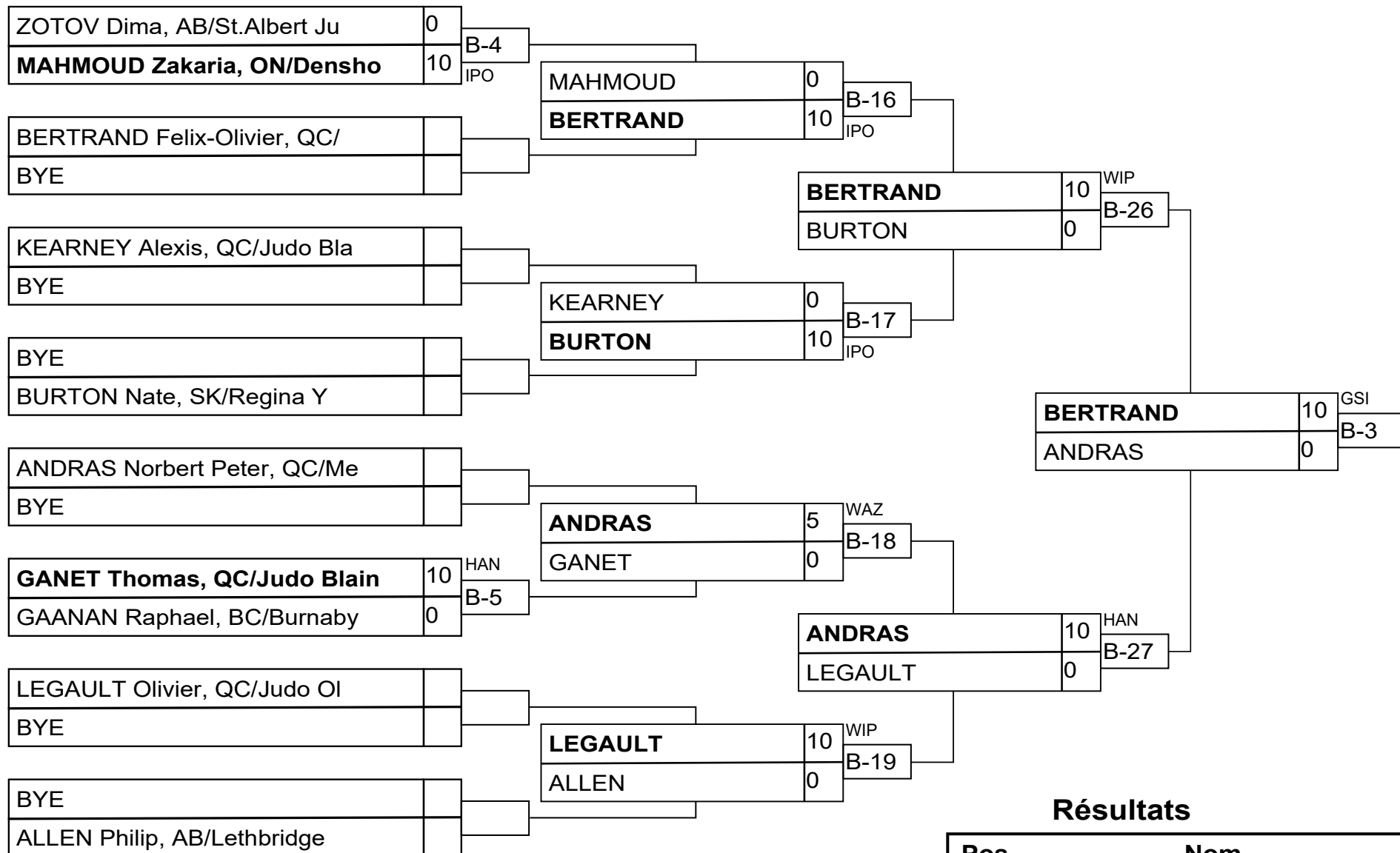

Résultats

| Pos | Nom |
|-----|--------------------------|
| 1 | BERTRAND Felix-Olivier, |
| 2 | ANDRAS Norbert Peter, QC |
| 3 | GANET Thomas, QC/Judo BI |
| 3 | LEGAULT Olivier, QC/Judo |

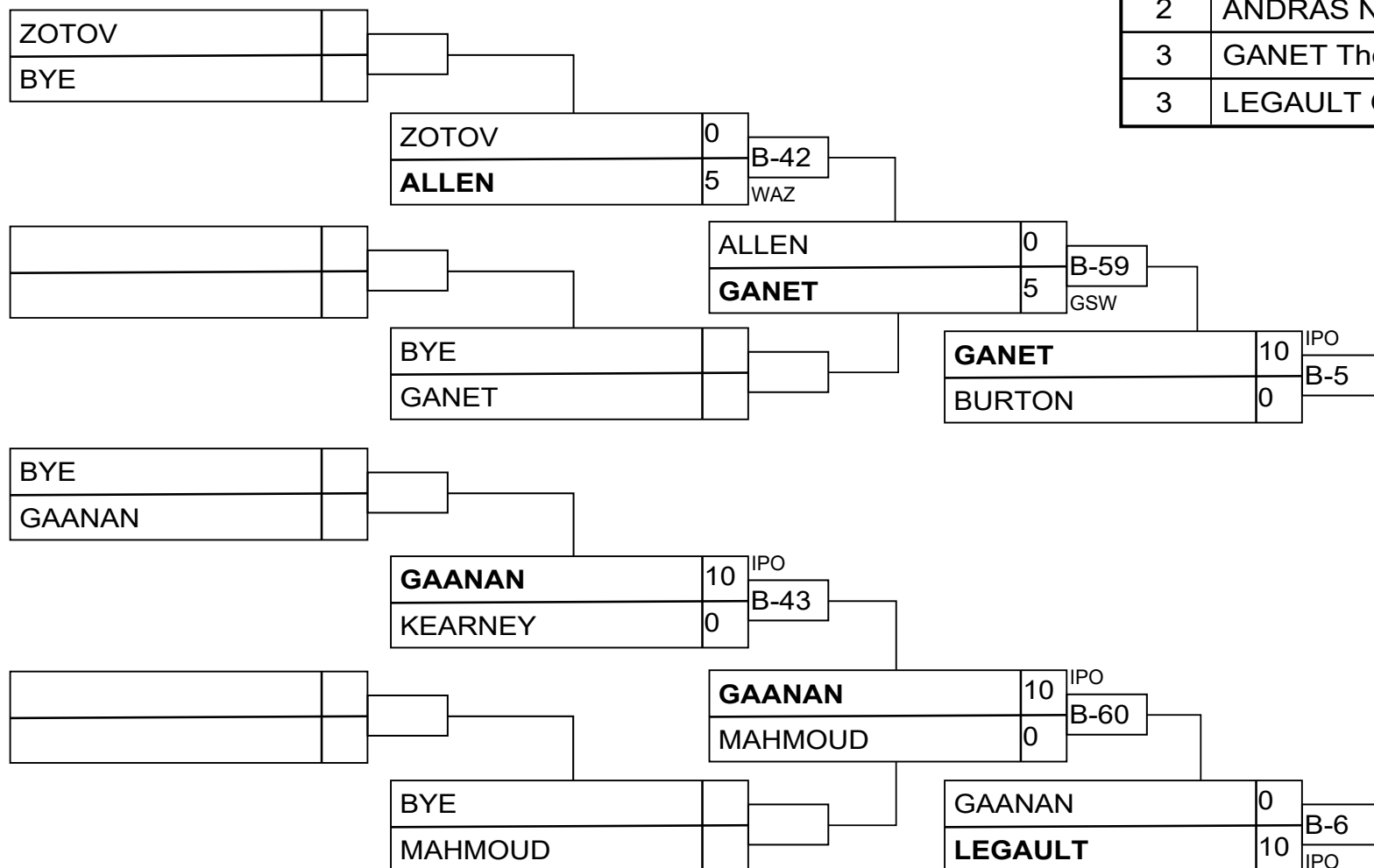

U18 M66KG

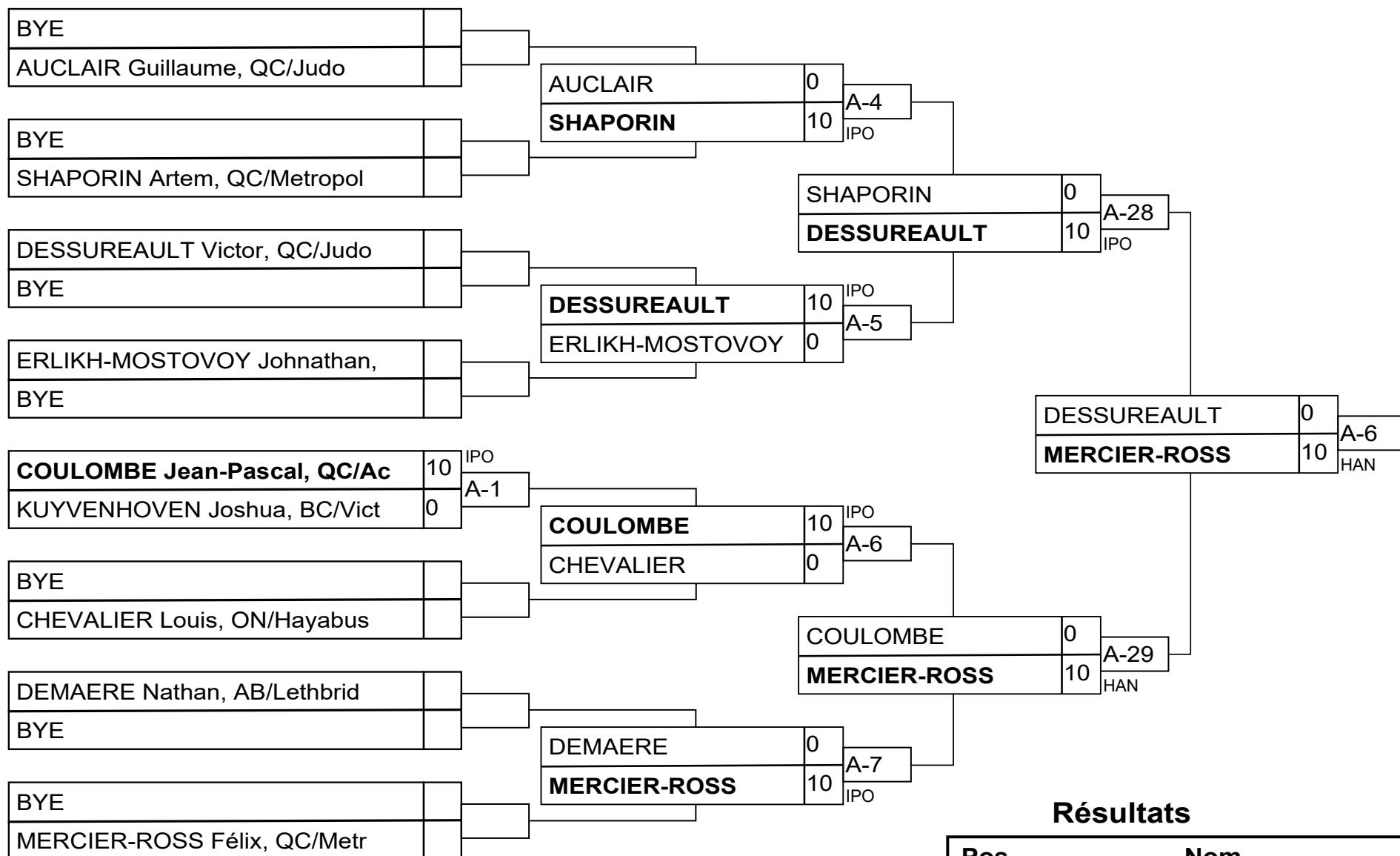

Résultats

| Pos | Nom |
|-----|--------------------------|
| 1 | MERCIER-ROSS Félix, QC/M |
| 2 | DESSUREAULT Victor, QC/J |
| 3 | DEMAERE Nathan, AB/Lethb |
| 3 | COULOMBE Jean-Pascal, QC |

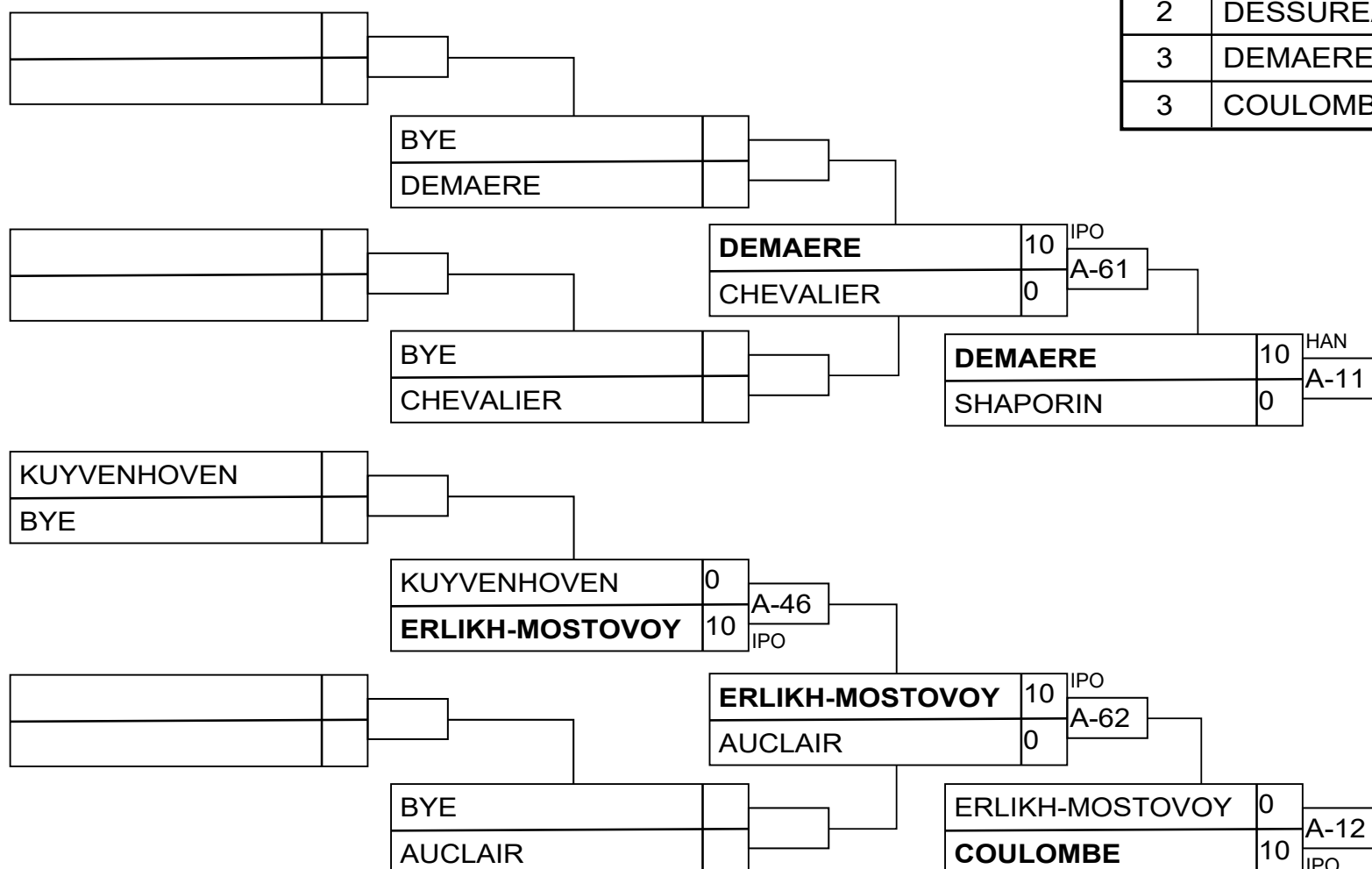

U18 M73KG

Compétiteurs A

| # | Nom | Club | 1 | 2 | 3 | 4 | Vic. | Pts | Pos |
|---|---------------------|------------------------|----|----|----|----|------|-----|-----|
| 1 | ALTHOUSE Carter | AB/Lethbridge Kyodokan | XX | | | | 0 | 0 | 4 |
| 2 | BATDORJ Munkhjin | QC/Shidokan | 10 | XX | 10 | 10 | 3 | 30 | 1 |
| 3 | SOLOVEICHIK Yonatan | ON | 10 | | XX | | 1 | 10 | 3 |
| 4 | RICHARDSON Kai | BC/Williams Lake | 10 | | 10 | XX | 2 | 20 | 2 |

Pool A

| Match | Blanc | | | Bleu | Résultat | Temps | Code |
|-------|---------------------|---|---|---------------------|----------|-------|------|
| B-30 | ALTHOUSE Carter | 1 | 2 | BATDORJ Munkhjin | 0 - 10 | 0:25 | IPO |
| B-31 | SOLOVEICHIK Yonatan | 3 | 4 | RICHARDSON Kai | 0 - 10 | 3:01 | IPO |
| B-46 | ALTHOUSE Carter | 1 | 3 | SOLOVEICHIK Yonatan | 0 - 10 | 1:10 | IPO |
| B-47 | BATDORJ Munkhjin | 2 | 4 | RICHARDSON Kai | 10 - 0 | 4:26 | GSW |
| B-63 | ALTHOUSE Carter | 1 | 4 | RICHARDSON Kai | 0 - 10 | 3:52 | IPO |
| B-64 | BATDORJ Munkhjin | 2 | 3 | SOLOVEICHIK Yonatan | 10 - 0 | 1:34 | IPO |

Compétiteurs B

| # | Nom | Club | 5 | 6 | 7 | Vic. | Pts | Pos |
|---|-----------------|--------------------|----|----|----|------|-----|-----|
| 5 | SEMENYUK Yuriy | QC/Métropolitain | XX | 10 | 5 | 2 | 15 | 1 |
| 6 | SPARKES Thomas | ON/Asahi Judo Club | | XX | 5 | 1 | 5 | 2 |
| 7 | KARPUKOV Arthur | QC/Shidokan | | | XX | 0 | 0 | 3 |

Pool B

| Match | Blanc | | | Bleu | Résultat | Temps | Code |
|-------|----------------|---|---|-----------------|----------|-------|------|
| B-32 | SEMENYUK Yuriy | 5 | 6 | SPARKES Thomas | 10 - 0 | 2:59 | IPO |
| B-48 | SEMENYUK Yuriy | 5 | 7 | KARPUKOV Arthur | 5 - 0 | 4:00 | GSW |
| B-65 | SPARKES Thomas | 6 | 7 | KARPUKOV Arthur | 5 - 0 | 4:00 | WAZ |

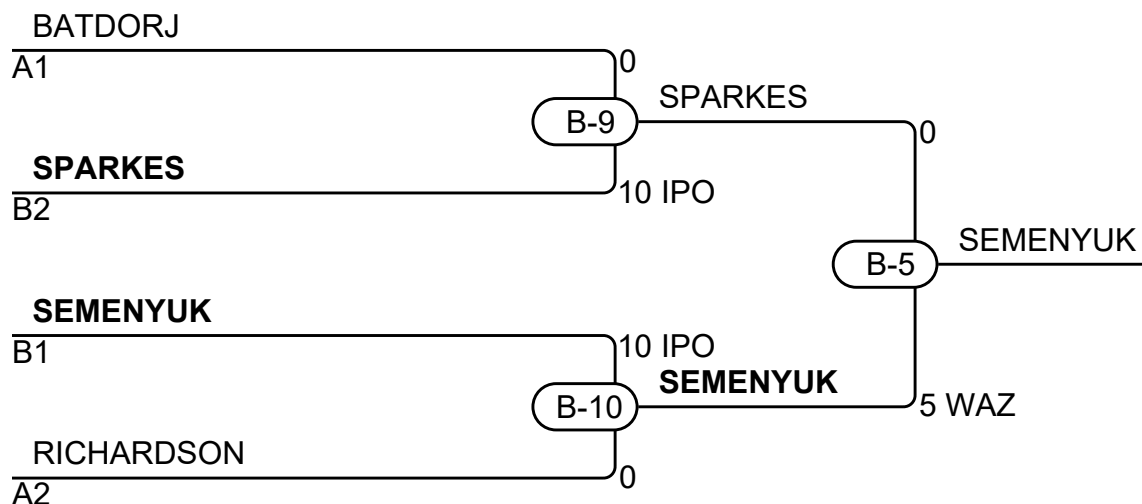

Résultats

| Pos | Nom |
|-----|------------------------------------|
| 1 | SEMENYUK Yuriy, QC/Métropolitain |
| 2 | SPARKES Thomas, ON/Asahi Judo Club |
| 3 | BATDORJ Munkhjin, QC/Shidokan |
| 3 | RICHARDSON Kai, BC/Williams Lake |

U18 M73KG (TB-A)

Compétiteurs

| # | Nom | Club | 1 | 2 | 3 | Vic. | Pts | Pos |
|---|---------------------|------------------------|----|----|----|------|-----|-----|
| 1 | RICHARDSON Kai | BC/Williams Lake | XX | 10 | 10 | 2 | 20 | 1 |
| 2 | SOLOVEICHIK Yonatan | ON | | XX | 10 | 1 | 10 | 2 |
| 3 | ALTHOUSE Carter | AB/Lethbridge Kyodokan | | | XX | 0 | 0 | 3 |

Matches

| Match | Blanc | | | Bleu | Résultat | Temps | Code |
|-------|---------------------|---|---|---------------------|----------|-------|------|
| D-1 | RICHARDSON Kai | 1 | 2 | SOLOVEICHIK Yonatan | 10 - 0 | 3:45 | GSI |
| D-2 | RICHARDSON Kai | 1 | 3 | ALTHOUSE Carter | 10 - 0 | 6:02 | HAN |
| D-3 | SOLOVEICHIK Yonatan | 2 | 3 | ALTHOUSE Carter | 10 - 0 | 1:34 | GSI |

Résultats

| Pos | Nom |
|-----|----------------------------------|
| 1 | RICHARDSON Kai, BC/Williams Lake |
| 2 | SOLOVEICHIK Yonatan, ON |
| | |

U18 M81KG

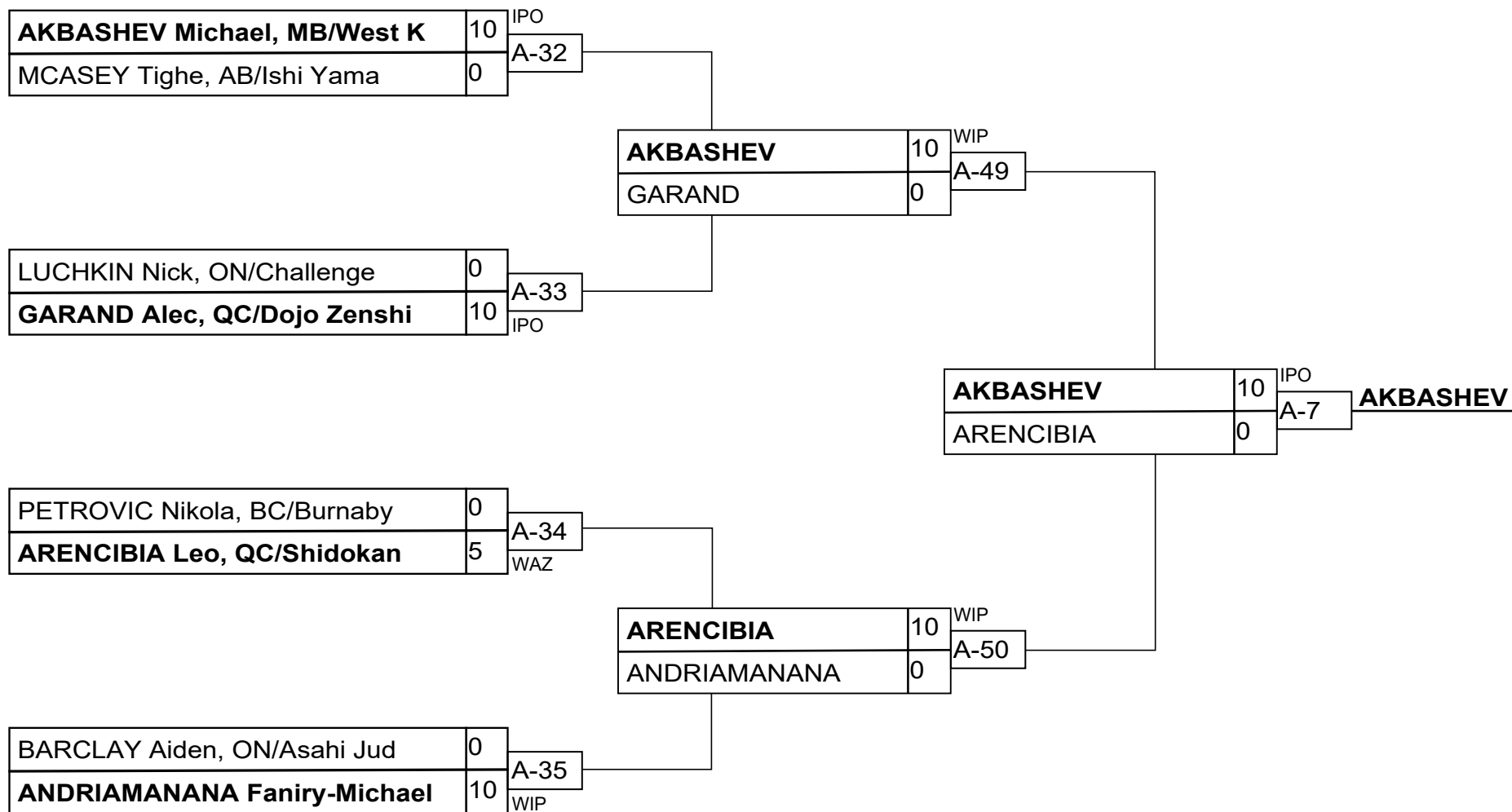

Résultats

| Pos | Nom |
|-----|--------------------------|
| 1 | AKBASHEV Michael, MB/Wes |
| 2 | ARENCIBIA Leo, QC/Shidok |
| 3 | GARAND Alec, QC/Dojo Zen |
| 3 | MCASEY Tighe, AB/Ishi Ya |

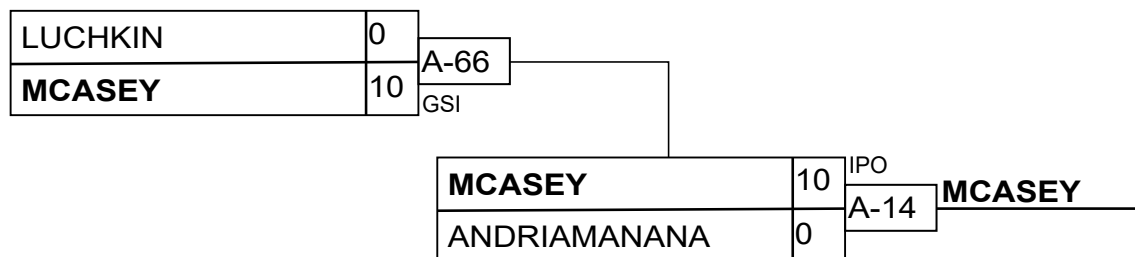
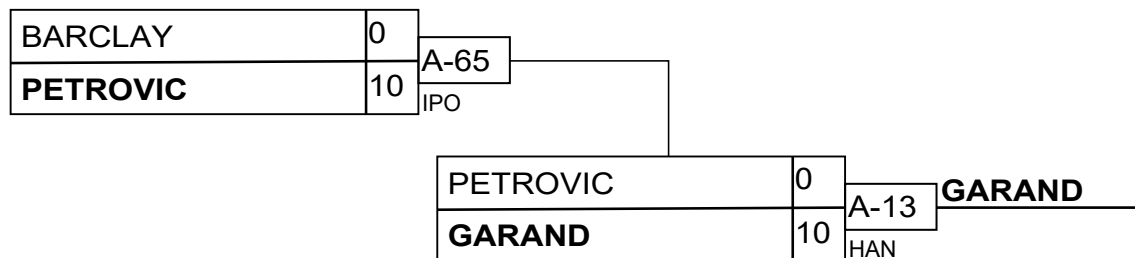

U18 M90KG

Compétiteurs A

| # | Nom | Club | 1 | 2 | 3 | 4 | Vic. | Pts | Pos |
|---|------------------|------------------------|----|----|----|----|------|-----|-----|
| 1 | JING Pierce | BC/Steveston Judo Club | XX | | | | 0 | 0 | 4 |
| 2 | ABDELREHIM Amr | ON/Sheffield judo club | 10 | XX | 10 | 10 | 3 | 30 | 1 |
| 3 | LOUAHLA Elias | QC/Metropolitain | 10 | | XX | 10 | 2 | 20 | 2 |
| 4 | AUGUSTINE Landon | PE/Gravity Judo Club | 10 | | | XX | 1 | 10 | 3 |

Pool A

| Match | Blanc | | | Bleu | Résultat | Temps | Code |
|-------|----------------|---|---|------------------|----------|-------|------|
| B-35 | JING Pierce | 1 | 2 | ABDELREHIM Amr | 0 - 10 | 0:26 | HAN |
| B-36 | LOUAHLA Elias | 3 | 4 | AUGUSTINE Landon | 10 - 0 | 0:51 | HAN |
| B-51 | JING Pierce | 1 | 3 | LOUAHLA Elias | 0 - 10 | 1:21 | IPO |
| B-52 | ABDELREHIM Amr | 2 | 4 | AUGUSTINE Landon | 10 - 0 | 0:40 | IPO |
| B-68 | JING Pierce | 1 | 4 | AUGUSTINE Landon | 0 - 10 | 1:46 | IPO |
| B-69 | ABDELREHIM Amr | 2 | 3 | LOUAHLA Elias | 10 - 0 | 1:34 | IPO |

Compétiteurs B

| # | Nom | Club | 5 | 6 | 7 | Vic. | Pts | Pos |
|---|---------------|-----------------------|----|----|----|------|-----|-----|
| 5 | CROOK Shion | AB/Hiro's Judo Club | XX | | 10 | 1 | 10 | 2 |
| 6 | MACUMBER Owen | ON/Ryudokan Judo Club | 10 | XX | 10 | 2 | 20 | 1 |
| 7 | LEMIEUX Jacob | QC/Judo Fermont | | | XX | 0 | 0 | 3 |

Pool B

| Match | Blanc | | | Bleu | Résultat | Temps | Code |
|-------|---------------|---|---|---------------|----------|-------|------|
| B-37 | CROOK Shion | 5 | 6 | MACUMBER Owen | 0 - 10 | 1:52 | IPO |
| B-53 | CROOK Shion | 5 | 7 | LEMIEUX Jacob | 10 - 0 | 1:07 | IPO |
| B-70 | MACUMBER Owen | 6 | 7 | LEMIEUX Jacob | 10 - 0 | 0:29 | IPO |

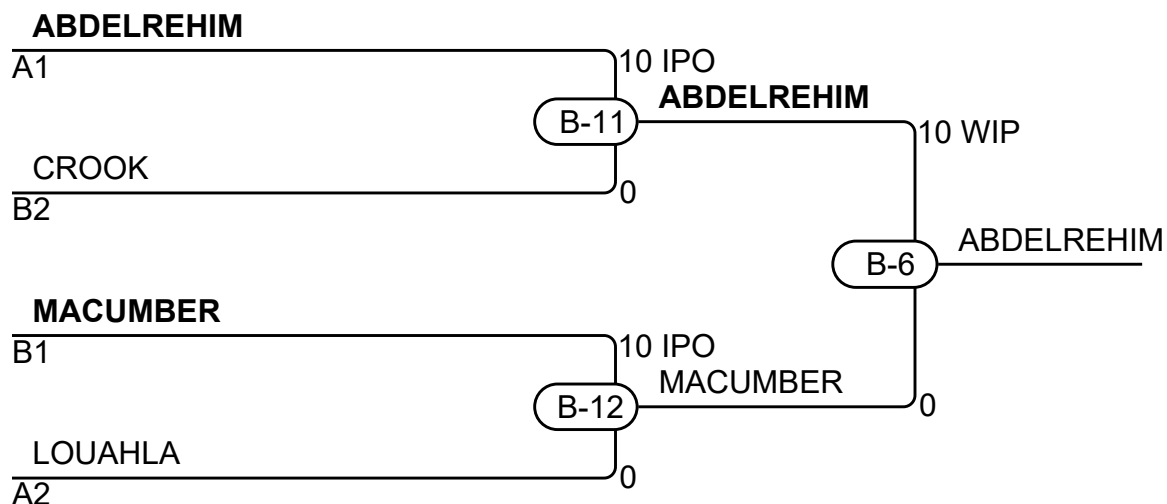

Résultats

| Pos | Nom |
|-----|--|
| 1 | ABDELREHIM Amr, ON/Sheffield judo club |
| 2 | MACUMBER Owen, ON/Ryudokan Judo Club |
| 3 | CROOK Shion, AB/Hiro's Judo Club |
| 3 | LOUAHLA Elias, QC/Metropolitain |

U18 Mo90kg

Compétiteurs

| # | Nom | Club | 1 | 2 | 1 | 2 | 1 | 2 | Vic. | Pts | Pos |
|---|-----------------|-------------------------|----|----|----|----|----|----|------|-----|-----|
| 1 | MESSE A John Jr | QC/Shidokan | XX | | XX | 10 | XX | 10 | 2 | 20 | 1 |
| 2 | ELLIOT Nolan | NT/Kam Lake Territorial | 10 | XX | | XX | | XX | 1 | 10 | 2 |

Matches

| Match | Blanc | | | Bleu | Résultat | Temps | Code |
|-------|-----------------|---|---|-----------------|----------|-------|------|
| B-38 | MESSE A John Jr | 1 | 2 | ELLIOT Nolan | 0 - 10 | 2:34 | IPO |
| B-54 | ELLIOT Nolan | 2 | 1 | MESSE A John Jr | 0 - 10 | 3:41 | HAN |
| B-71 | MESSE A John Jr | 1 | 2 | ELLIOT Nolan | 10 - 0 | 1:37 | IPO |

Résultats

| Pos | Nom |
|-----|--|
| 1 | MESSE A John Jr, QC/Shidokan |
| 2 | ELLIOT Nolan, NT/Kam Lake Territorial Center |